

SFH 608 PHOTOTRANSISTOR, 5.3 KV, TRIOS® LOW CURRENT OPTOCOUPLER

FEATURES

- **Very High CTR at $I_F=1$ mA, $V_{CE}=0.5$ V**
 - SFH608-2, 63-125%
 - SFH608-3, 100-200%
 - SFH608-4, 160-320%
 - SFH608-5, 250-500%
- **Specified Minimum CTR at $I_F=0.5$ mA, $V_{CE}=1.5$ V: $\geq 32\%$ (typ. 120%)**
- **Good CTR Linearity with Forward Current**
- **Low CTR Degradation**
- **High Collector-Emitter Voltage $V_{CEO}=55$ V**
- **Isolation Test Voltage: 5300 VAC_{RMS}**
- **Low Current Input**
- **Low Coupling Capacitance**
- **High Common Mode Transient Immunity**
- **Phototransistor Optocoupler in 6 Pin DIP Package**
- **Field Effect Stable: TRIOS®**
- **VDE 0884 Available with Option 1**
- **Underwriters Lab File #E52744**
- **Applications**
 - Telecommunications
 - Industrial Controls
 - Office Machines
 - Microprocessor System Interfaces

DESCRIPTION

The SFH 608 is an optocoupler designed for high current transfer ratio at low input currents with the output transistor saturated. This makes the device ideal for low current switching applications. The SFH608 is packaged in a six pin plastic DIP.

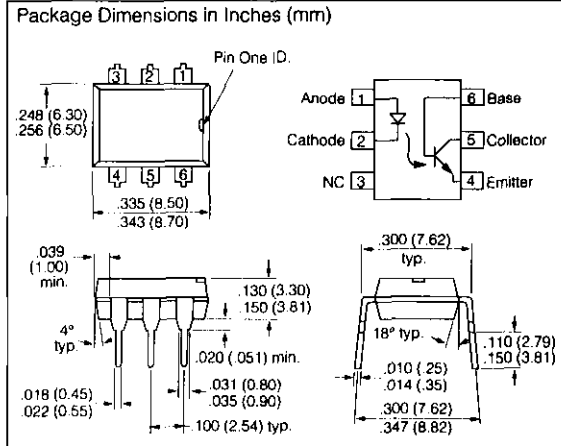

Maximum Ratings ($T_A=25^\circ\text{C}$)

Emitter

Reverse Voltage	6 V
DC Forward Current	50 mA
Surge Forward Current ($t_p \leq 10 \mu\text{s}$)	2.5 A
Total Power Dissipation	70 mW

Detector

Collector-Emitter Voltage	55 V
Collector-Base Voltage	55 V
Emitter-Base Voltage	7 V
Collector Current	50 mA
Surge Collector Current ($t_p \leq 1$ ms)	100 mA
Total Power Dissipation	150 mW
Isolation Test Voltage (between emitter and detector referred to climate DIN 40046 part 2 Nov. 74) ($t=1$ sec.)	5300 VAC _{RMS}
Creepage	≥ 7 mm
Clearance	≥ 7 mm
Comparative Tracking Index per DIN IEC 112/VDE 0303, part 1	175
Isolation Resistance	
$V_{IO}=500$ V, $T_A=25^\circ\text{C}$	$\geq 10^{12} \Omega$
$V_{IO}=500$ V, $T_A=100^\circ\text{C}$	$\geq 10^{11} \Omega$
Storage Temperature Range	-55°C to $+150^\circ\text{C}$
Operating Temperature Range	-55°C to $+100^\circ\text{C}$
Junction Temperature	100°C
Soldering Temperature (max. 10 sec., dip soldering: distance to seating plane ≥ 1.5 mm)	260°C

*TRIOS—TRansparent IO n Shield

Characteristics ($T_A=25^\circ\text{C}$, unless otherwise specified)

	Symbol	Typ.	Unit	Condition
Emitter				
Forward Voltage	V_F	1.1 (≤ 1.5)	V	$I_F=5\text{ mA}$
Reverse Voltage	V_R	(≥ 6)	V	$I_R=10\ \mu\text{A}$
Reverse Current	I_R	0.01 (≤ 10)	μA	$V_R=6\text{ V}$
Capacitance	C_O	25	pF	$V_R=0\text{ V}$, $f=1\text{ MHz}$
Thermal Resistance	R_{thJA}	1070	K/W	
Detector				
Collector-Emitter Voltage	V_{CEO}	≥ 55	V	$I_{\text{CE}}=10\ \mu\text{A}$
Emitter-Base Voltage	V_{EBO}	≥ 7	V	$I_{\text{EB}}=10\ \mu\text{A}$
Capacitance	C_{CE}	10	pF	$V_{\text{CE}}=5\text{ V}$, $f=1\text{ MHz}$
Capacitance	C_{CB}	16	pF	$V_{\text{CB}}=5\text{ V}$, $f=1\text{ MHz}$
Capacitance	C_{EB}	10	pF	$V_{\text{EB}}=5\text{ V}$, $f=1\text{ MHz}$
Thermal Resistance	R_{thJA}	500	K/W	
Package				
Coupling Capacitance	C_C	0.60	pF	
Coupling Transfer Ratio				
SFH 608-2	I_C/I_F	63-125	%	$I_F=1\text{ mA}$, $V_{\text{CE}}=0.5\text{ V}$
		75 (≥ 32)	%	$I_F=0.5\text{ mA}$, $V_{\text{CE}}=1.5\text{ V}$
SFH 608-3	I_C/I_F	100-200	%	$I_F=1\text{ mA}$, $V_{\text{CE}}=0.5\text{ V}$
		120 (≥ 50)	%	$I_F=0.5\text{ mA}$, $V_{\text{CE}}=1.5\text{ V}$
SFH 608-4	I_C/I_F	160-320	%	$I_F=1\text{ mA}$, $V_{\text{CE}}=0.5\text{ V}$
		200 (≥ 80)	%	$I_F=0.5\text{ mA}$, $V_{\text{CE}}=1.5\text{ V}$
SFH 608-5	I_C/I_F	250-500	%	$I_F=1\text{ mA}$, $V_{\text{CE}}=0.5\text{ V}$
		300 (≥ 125)	%	$I_F=0.5\text{ mA}$, $V_{\text{CE}}=1.5\text{ V}$
Collector-Emitter Saturation Voltage				
SFH 608-2	V_{CESat}	0.25 (≤ 0.4)	V	$I_C=0.32\text{ mA}$, $I_F=1\text{ mA}$
SFH 608-3	V_{CESat}	0.25 (≤ 0.4)	V	$I_C=0.5\text{ mA}$, $I_F=1\text{ mA}$
SFH 608-4	V_{CESat}	0.25 (≤ 0.4)	V	$I_C=0.8\text{ mA}$, $I_F=1\text{ mA}$
SFH 608-5	V_{CESat}	0.25 (≤ 0.4)	V	$I_C=1.25\text{ mA}$, $I_F=1\text{ mA}$
Collector-Emitter Leakage Current	I_{CEO}	10 (≤ 200)	nA	$V_{\text{CE}}=10\text{ V}$

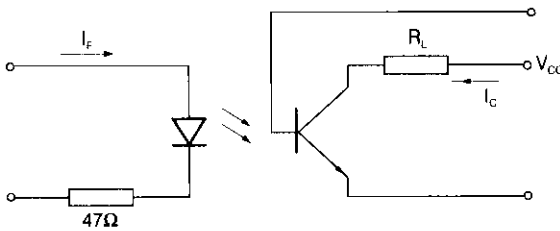

$I_C=2\text{ mA}$ (to adjust by I_F), $R_L=100\ \Omega$, $T_A=25^\circ\text{C}$, $V_{\text{CC}}=5\text{ V}$

Description	Symbol	Values	Unit
Turn-On Time	t_{ON}	8	μs
Rise Time	t_R	5	μs
Turn-Off Time	t_{OFF}	7.5	μs
Fall Time	t_F	7	μs

Figure 1. Switching times $T_A=25^\circ\text{C}$, $I_F=1\text{ mA}$, $V_{\text{CC}}=5\text{ V}$, t_{ON} , t_R , t_{OFF} , $t_F=f(R_L)$

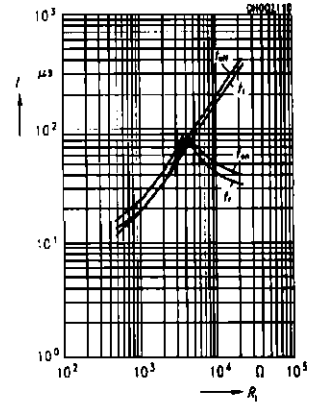

Figure 2. Current transfer ratio (typ.) $V_{\text{CE}}=0.5\text{ V}$, $\text{CTR}=f(T_A, I_F)$

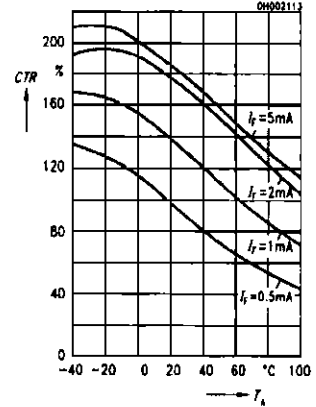

Figure 3. Current transfer ratio (typ.) $V_{\text{CE}}=1.5\text{ V}$, $\text{CTR}=f(T_A, I_F)$

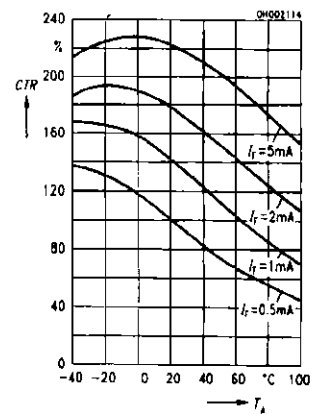

Figure 4. Diode forward voltage (typ.)
 $T_A=25^\circ\text{C}$, $V_F=f(I_F)$

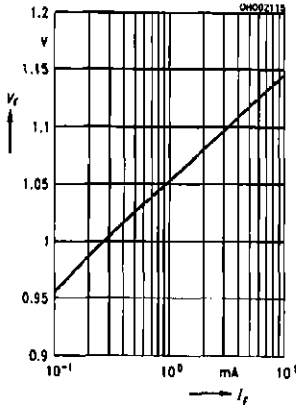

Figure 5. Diode forward voltage (typ.) $I_F=1\text{ mA}$, $V_F=f(T_A)$

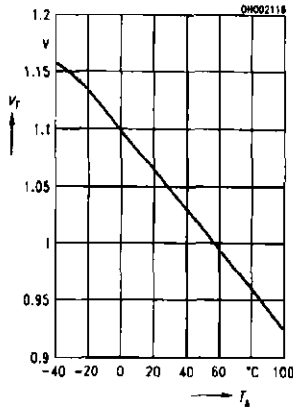

Figure 6. Output characteristics (typ.)
 $T_A=25^\circ\text{C}$, $I_{CE}=f(V_{CE}, I_B)$

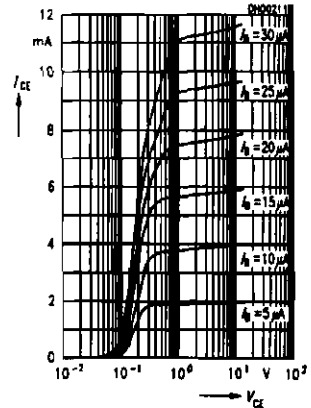

Figure 7. Output characteristics (typ.)
 $T_A=25^\circ\text{C}$, $I_{CE}=f(V_{CE}, I_F)$

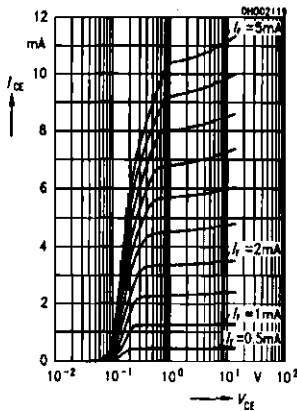

Figure 8. Permissible forward current diode $I_F=f(T_A)$

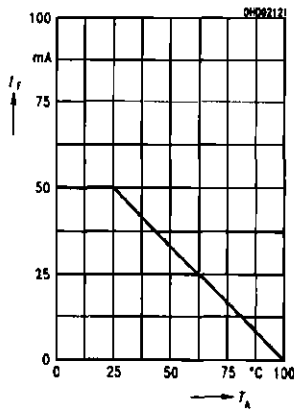

Figure 9. Permissible power dissipation $P_{TOT}=f(T_A)$

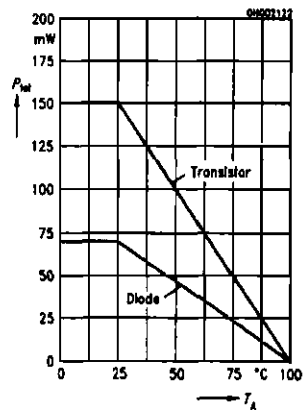

Figure 10. Transistor capacitance (typ.) $T_A=25^\circ\text{C}$, $f=1\text{ MHz}$, $C_{CE}=f(V_{CE})$
 $C_{CB}=f(V_{CB})$, $C_{EB}=f(V_{EB})$

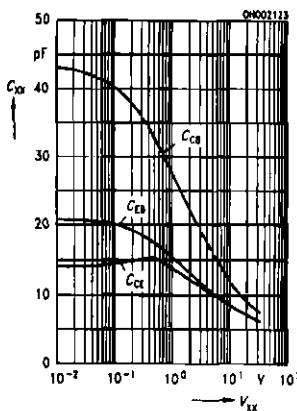

Figure 11. Collector-emitter leakage current $I_F=0$, $V_{CE}=10\text{ V}$, $I_{CEO}=f(T_A)$

